

THERMAL VISION FOR RECREATIONAL BOATING



The World's *Sixth Sense*[®]

NIGHT TIME ON THE WATER MADE SAFER— WITH FLIR

FLIR maritime thermal imaging systems turn night into day, keeping you safe and secure on the water, and letting you boat with confidence.

SEE THE HEAT

Thermal imaging cameras detect and display images based on tiny differences in heat, not light. From pitch black to moonlight to severe midday glare—FLIR detectors capture the thermal energy emitted or reflected by everything, even ice. FLIR cameras then convert the small differences in temperature into easy-to-interpret infrared video images, allowing you to see at night and navigate in total darkness.



CONTENTS

- 4 The Thermal Advantage
- 8 Understanding Resolution and Range
- 10 Ocean Scout Handheld Thermal Camera
- 12 MD-Series Fixed Mount Thermal Cameras
- 14 M132 and M232 Marine Thermal Vision Cameras
- 16 M-Series Next Generation Thermal Vision Cameras
- 20 M400 and M400-XR Multi-Sensor Camera System
- 26 M500 Cooled Multi-Sensor Camera System
- 32 Features Comparison Chart
- 34 Specifications



FROM KAYAKS TO SUPER YACHTS, FLIR OFFERS CUTTING-EDGE MARINE THERMAL CAMERAS THAT ARE RUGGED, RELIABLE, AND SIMPLE TO USE.

THE THERMAL ADVANTAGE

BOAT SAFER AND AVOID DANGER



Day or night FLIR thermal imaging detects obstacles like jetties, rocks, navigation aids and more. Charged by daylight these objects continue to emit infrared heat all night long.



Thermal imaging instantly detects kayaks, paddleboards, and personal watercraft. The kayaker's own body heat makes him a bright target for FLIR thermal imaging.

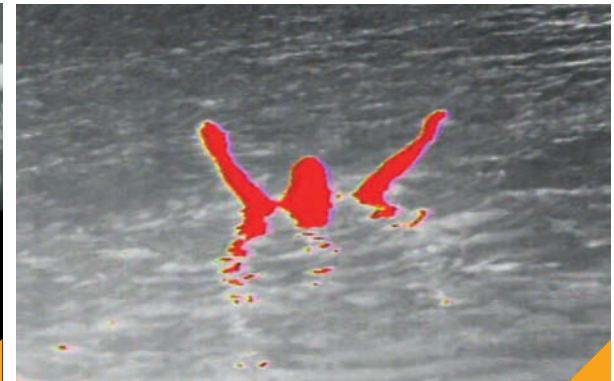

Thermal imaging is the fastest way to detect a person in the water. FLIR's InstAlert™ color palette can even highlight the hottest target in a scene in red, making detection faster and easier.

ENHANCED SITUATIONAL AWARENESS



FLIR thermal imagers make it easy to confirm the positions of navigation aids and landmarks. Systems with pan, tilt and zoom gimbals can even integrate with select multifunction navigation displays and radar systems making target ID even easier.

Thermal imaging instantly reveals other vessels masked by background lighting and solar glare. Because they use heat and not light to see, FLIR cameras deliver the same high-quality images day or night.

NAVIGATE SMARTER



Thermal imaging not only lets you see approaching vessels, but also the activities of those onboard. Many systems offer digital and optical zoom to further enhance small or distant objects.



SEE AT NIGHT

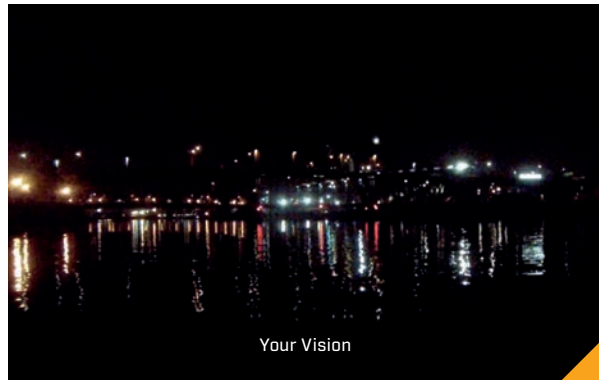

Your Vision: Floating debris is almost impossible to spot at night, especially with bright urban back lighting.



FLIR Vision: Thermal imaging easily detects the floating box, as well as the bridge span ahead. The thermal camera is completely immune to the effects of bright city lights and glare.



In addition to the power of thermal vision, some FLIR maritime cameras feature video analytics technology for recognizing and automatically tracking objects in the camera's field of view.

YOUR VISION VERSUS FLIR VISION



Your Vision: Emergency lights on a police boat mask its navigation lights making it hard to determine its aspect at night.



FLIR Vision: Thermal imaging is immune to visible light and glare. Not only can we clearly see the police boat, we can also see the buoy and jetty astern of it.

Thermal imaging works night and day, in total darkness or bright sunlight, through smoke, dust, and even light fog to keep your passengers and crew safe from hazards and threats.

FLIR - THE WORLD'S SIXTH SENSE



At FLIR we develop a wide range of technologies that enhance perception and awareness. We bring innovative sensing solutions into daily life through our thermal imaging, visible-light imaging systems, location technologies, measurement and diagnostic products, and advanced threat detection systems. Our products improve the way people interact with the world around them, enhance public safety and well-being, increase energy efficiency, and enable healthy and entertained communities.

UNDERSTANDING RESOLUTION AND RANGE

FLIR offers a range of thermal imaging cameras with varying levels of image resolution. Much like a digital camera, FLIR cameras with higher pixel counts offer more detail, but more importantly high resolution thermal cameras see objects at greater distances. For example, an uncooled 640 resolution FLIR camera can detect a vessel at almost twice the range of 320 resolution camera. Premium cameras with enhanced optics and cooled thermal cores offer even longer-range target detection capabilities.



Thermal imagers with lower resolution provide good basic target detection and identification at short to medium ranges.



The increased pixel density of the high resolution systems give them higher sensitivity at long range, increased contrast, and more lifelike detail.

VISION IN TOTAL DARKNESS

Daylight cameras, image intensified night vision (I²), and the human eye all create images from reflected light. Traditional green night vision scopes and goggles all take in small amounts of visible light and magnify it. However, traditional imagers have the same limitations as the human eye: if there isn't enough light available, they don't work well. Plus, during daylight and twilight hours, they aren't useful either because there is too much light for them to work effectively.

FLIR thermal cameras work both day and night, regardless of light. They're totally immune to the effects of darkness, glare, or even direct sunlight.

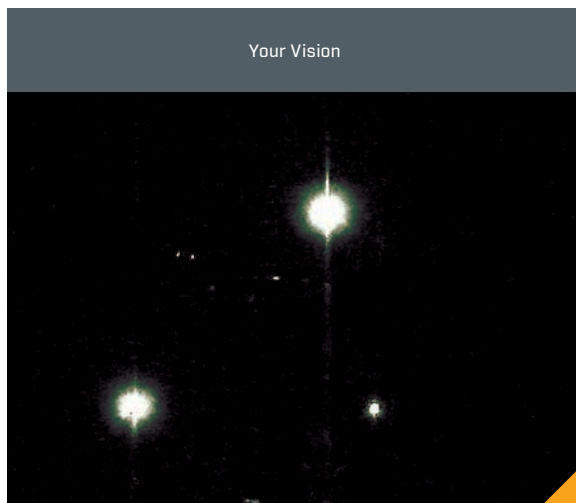

Your Vision

The human eye can't react well to darkness pierced by bright lighting. The lights of the approaching vessel are blinding, making it impossible to see the details.



Traditional Gen3 Image Intensified Night Vision

Image Intensified Night Vision scopes and goggles are also at a disadvantage. They over-magnify the lighting in the scene, hurting your eyes and concealing important details.

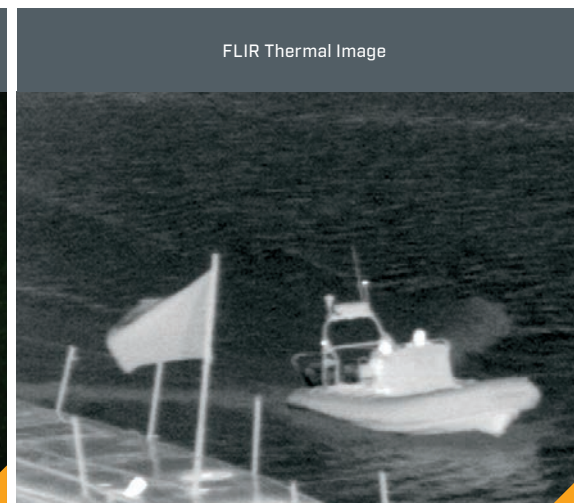







FLIR Thermal Image

Since the thermal camera sees heat and not light, it is immune to the blinding effects of the boat's navigation lights. We can clearly see 2 occupants in the approaching RIB.

FLIR *Ocean Scout*



OCEAN SCOUT FEATURES

-  Compact and lightweight
-  Easy-to-use 3-button design
-  Analog video output sends camera display to an external monitor or recorder (320 & 640 models only)
-  White Hot, Black Hot and InstAlert™ detection palettes
-  Convenient LED spotlight for use when the camera is powered off
-  Available in 240 x 180, 336 x 256, and 640 x 512 (9 Hz) resolutions
-  2x E-Zoom available on 320, 2x and 4x on 640

HANDHELD THERMAL CAMERA

Ocean Scout is a rugged, compact thermal night vision camera that reveals other vessels, landmarks, buoys, and floating debris day or night. Now with a high resolution LCD display and FLIR's industry-leading sensor technology, Ocean Scout puts enhanced situational awareness in your hand at a moment's notice.

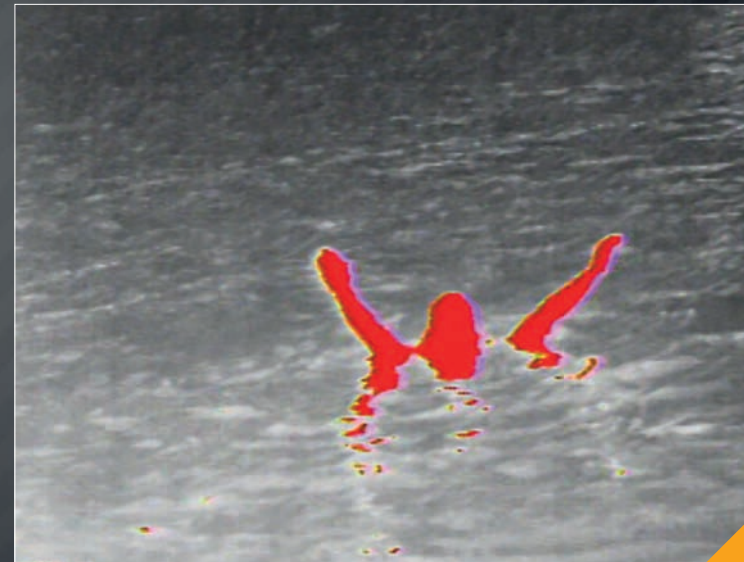

Find people overboard faster with InstAlert™

OCEAN SCOUT DETECTION RANGES*

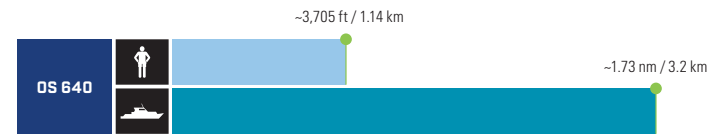
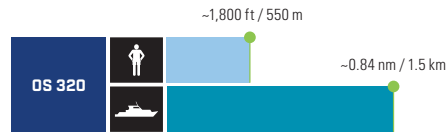
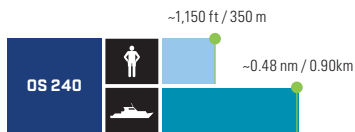







*Actual range may vary depending on camera set-up, environmental conditions, and user experience.

FLIR MD-Series™



MD-SERIES FEATURES

-  320 x 240 or 640 x 480 resolutions produces clear, detailed images
-  2x E-Zoom available on MD-324, 2x and 4x on MD-625
-  Automatic window heater keep optics free of ice
-  Ethernet-enabled for simple integration into your current electronics
-  Slim profile (7" high and only 1.36 kg/3 lbs) for an unobtrusive mount
-  Analog video output for easy connection to onboard monitors, recorders, or DVR systems

FIXED MOUNT MARINE THERMAL VISION

This affordable, fixed-mount thermal night vision system helps you steer around obstacles, avoid collisions, and find people in the water, day or night. The MD camera body is simple to mount and easy to integrate into existing electronics. Mount the display separately on your helm, or view the video feed using existing multifunction navigation displays from leading manufacturers, including Furuno, Garmin, Raymarine, and Simrad.

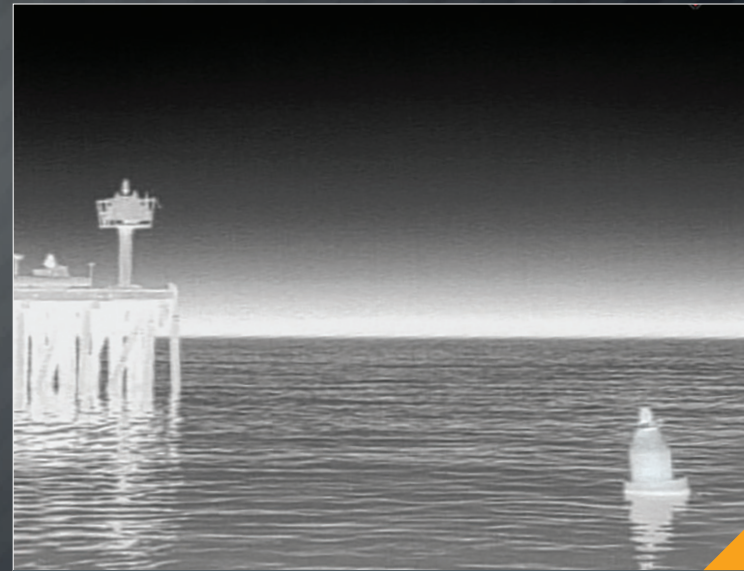

Easily see navigation aids

MD-SERIES DETECTION RANGES*

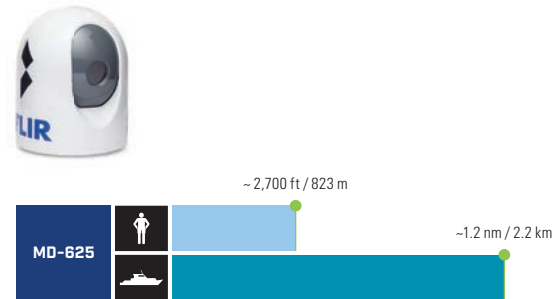



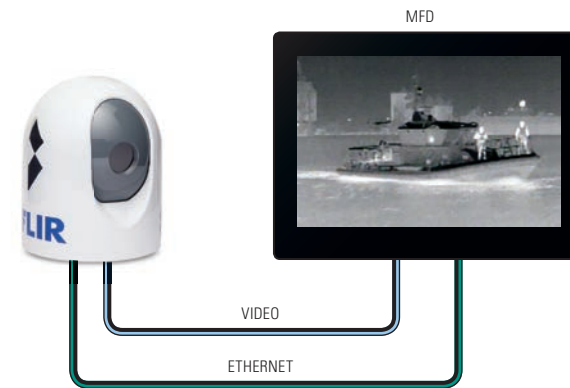



*Actual range may vary depending on camera set-up, environmental conditions, and user experience.



FLIR M132/232 Series



M132/M232-SERIES FEATURES

-  320x240 resolution for clear, detailed images
-  4x continuous e-Zoom magnifies distant targets for easy identification
-  Ethernet-enabled for simple integration with your other electronics
-  M132 with adjustable tilt
-  360° pan and +/-90° tilt capability
-  Rugged, waterproof gimbal enclosure with automatic window heaters for ice management.
-  IP video for integration with latest state-of-the-art navigation displays. Check FLIR.com for a list of compatible displays

COMPACT MARINE THERMAL VISION CAMERAS

The M132 and M232 marine thermal night vision cameras from FLIR take affordability and easy integration to a whole new level. Packing 320x240 thermal resolution, video over IP, and digital zoom into FLIR's smallest, camera housing, the M132 and M232 enhance awareness and make navigation safer on any vessel.



Available ClearCruise IR Analytics alert you to hazards and obstacles on the water**

IR ANALYTICS- ENHANCED AWARENESS

Combine the M132 or M232 with a Raymarine Axiom MFD and take advantage of FLIR ClearCruise™ intelligent thermal analytics. ClearCruise provides audible and visual alerts when "non-water" objects such as boats, obstacles, or navigation markers are identified in the scene.



DETECTION RANGES*



*Actual range may vary depending on camera set-up, environmental conditions, and user experience.



REMOTE CONTROL

Control the M132/M232 from your MFD or add the optional JCU-3 control unit.

FLIR M-Series™

NEXT GENERATION



M-SERIES NEXT GENERATION FEATURES

- Active gyro-stabilization automatically keeps the image steady in rough seas
- Dual Payload models feature a high resolution color camera system with 36x Optical Zoom and low-light mode
- 4x continuous e-Zoom magnifies distant targets for easy identification
- Ethernet control link for easy networking to FLIR joysticks or multifunction displays
- Standard analog video signal displays on any monitor with an auxiliary video input
- Rugged, waterproof gimbal enclosure with automatic window heaters for ice management.
- 360° pan and +/-90° tilt capability

NEXT GENERATION MARINE THERMAL VISION CAMERAS

Our most popular line of maritime thermal cameras is now even better. M-Series Next Generation cameras are equipped with gyro-stabilization on every model and deliver smooth and steady imagery when seas turn rough. The Next Generation M-Series are equipped with our latest generation Tau-2 thermal core for sharper details and enhanced image quality. Dual payload models also feature an enhanced color lowlight zoom video camera for stunning daytime and nighttime performance.



Spot navigation aids with ease day or night



Control and view M-Series direct from your MFD. The M-Series integrate seamlessly with existing electronics including select multifunction displays from Furuno, Garmin, Raymarine and Simrad. M-Series cameras are also supplied with a joystick control unit, giving you full control of the camera.



GYRO-STABILIZATION

FLIR M-Series single and dual-payload thermal cameras feature active gyro-stabilization so the cameras always deliver steady pictures, even in rough seas.

FLIR M-Series™

NEXT GENERATION



SINGLE OR DUAL PAYLOAD

Choose a single or dual payload M-Series camera. Dual Payload models are equipped with a 36x zoom color lowlight camera for enhanced daylight and lowlight viewing.

Single Payload

Dual Payload



~1,500 ft / 457 m

M-324S
M-324CS



~0.67 nm / 1.3 km



~2,700 ft / 823 m

M-625S
M-625CS



~1.2 nm / 2.2 km

M-SERIES NEXT GENERATION MARINE THERMAL VISION CAMERAS

M-Series Next Generation cameras are available in several configurations. Choose a single payload model for thermal vision only or step up to a dual payload model with a 36x zoom color lowlight camera. The addition of the visible camera provides improved object recognition in lowlight conditions. 320x240 resolution models offer high quality FLIR thermal vision and all around safe navigation. The higher resolution 640x480 models offer improved range and better image quality. Each M-Series camera is supplied with a joystick control unit for full camera control.



"2017 NMEA PRODUCT OF EXCELLENCE AWARD WINNER"

Cameras can be installed upside down if required

SMARTER NAVIGATION: ADVANCED RADAR AND GPS INTEGRATION

Combine an M-Series camera with your multifunction display and experience a new level of situational awareness. Get more out of your radar by easily discerning radar targets using thermal imagery. Some MFDs offer advanced integration features like target slew-to-cue, allowing the camera to automatically follow AIS, ARPA or selected chart objects. Check your with your MFD manufacturer for complete thermal camera compatibility.

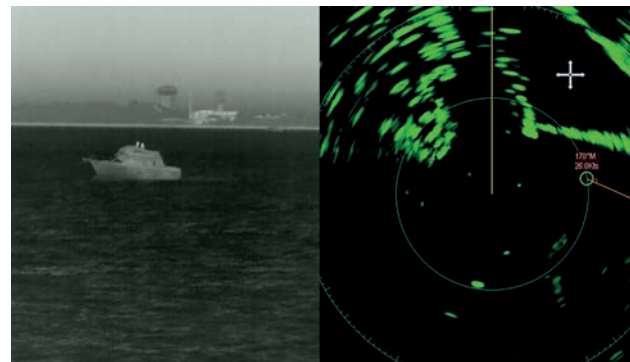

Boat or Buoy? FLIR technology helps you easily recognize hard to identify radar targets.

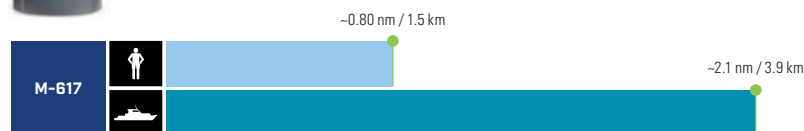

*Actual range may vary depending on camera set-up, environmental conditions, and user experience.

FLIR M400 / M400XR



M400 AND M400XR FEATURES

- High intensity LED spot-beam can highlight targets of interest while preserving the night vision of on-deck personnel
- HD Color lowlight camera with 30x optical zoom
- Gyro stabilized to ensure steady viewing in heavy sea conditions
- High resolution 640 x 480 thermal sensor with 4x continuous optical zoom and 4x digital E zoom
- Rugged, waterproof gimbal enclosure with automatic window heaters for ice management.
- 360° pan and +/-90° tilt capability
- IP Video, HD-SDI, and Analog video outputs and integration with navigation displays
- Video tracking: follow objects in the camera's view (M400XR only)
- Firefighting mode optimizes color palette to see hot spots and measure temperature on scene (M400XR only)

MULTI-SENSOR MARINE CAMERA SYSTEM

THERMAL CAMERA WITH CONTINUOUS OPTICAL ZOOM

M400's thermal camera features a 4x optical zoom lens plus an additional 4X digital zoom. See beyond visual range to identify distant contacts, or magnify small objects for easy identification. With continuous optical zoom, targets remain in clear, crisp focus right up to maximum magnification. Use the digital zoom to further expand the thermal image, making maximum usage of even the smallest pixels.

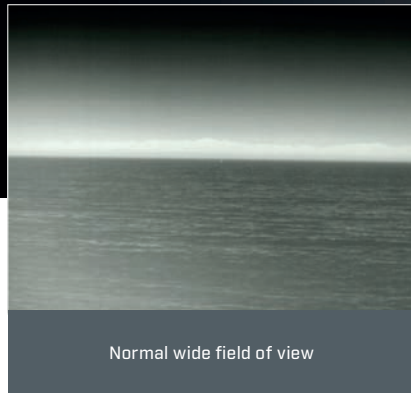

The M400's optical zoom helps to positively identify distant targets



DETECTION RANGES*

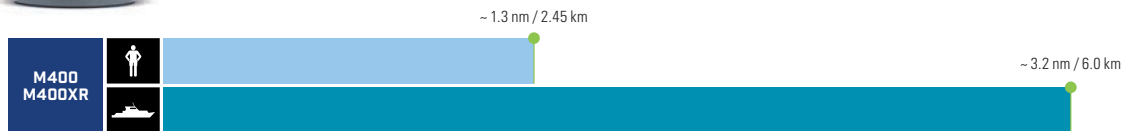

*Actual range may vary depending on camera set-up, environmental conditions, and user experience.

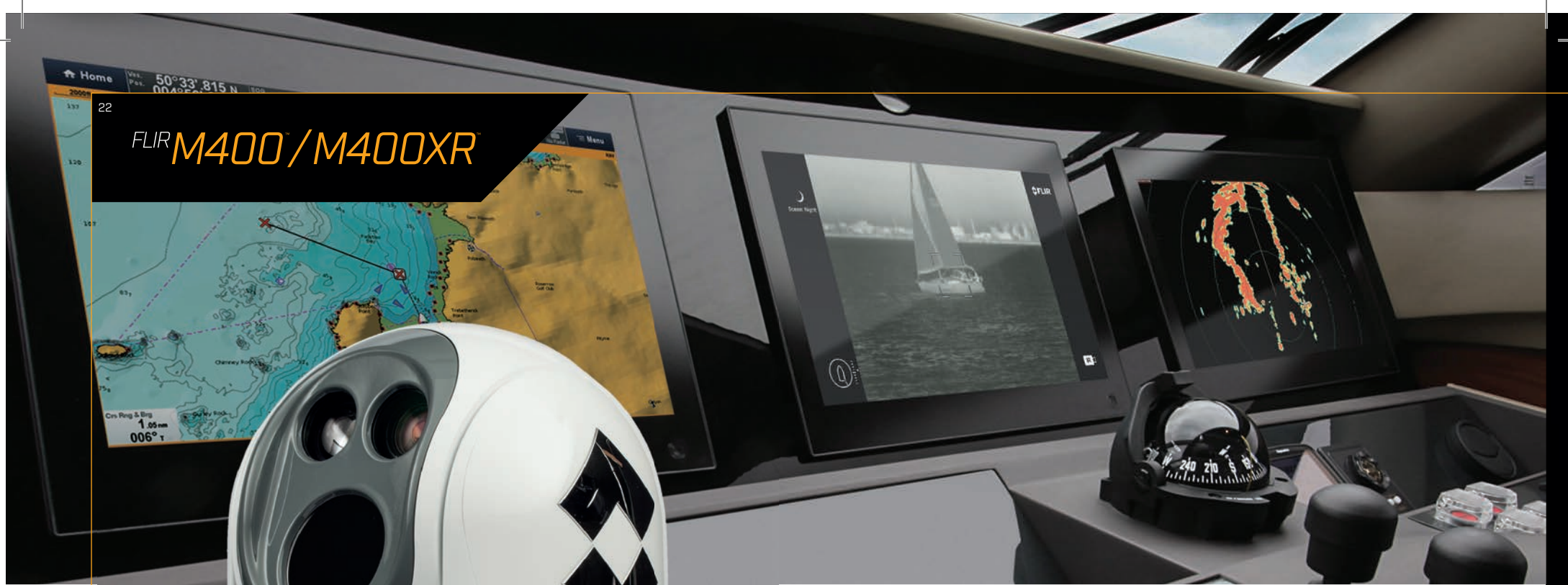

FLOATING ICE DETECTION AND AVOIDANCE

Night-time collisions with sea ice are a legitimate hazard to expedition yachts, commercial vessels and rescue craft operating in high latitudes and wintery conditions. FLIR systems with IceAlert™ mode can enhance situational awareness by highlighting growlers, bergy bits, and icebergs in shades of blue.

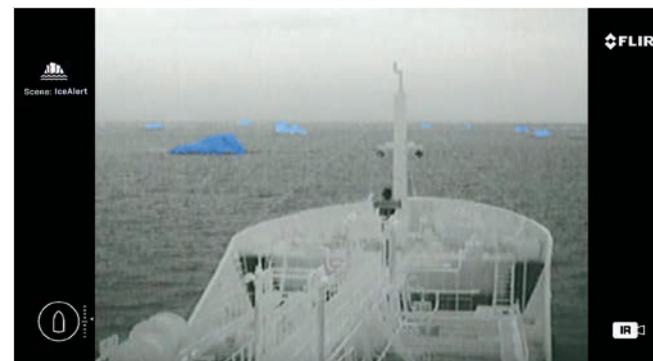

Ice detection mode

MULTI-SENSOR MARINE CAMERA SYSTEM

HD ZOOM VIDEO CAMERA

Better than binoculars, M400 is equipped with a built-in color high-definition camera with optical zoom and lowlight imaging. Use the video camera to make positive identification of other vessels, navigation aids, and more. Use its 30x optical zoom to see all the details, and assess situations from a safe distance. Video and thermal zoom controls can be linked for easy comparison or simultaneous viewing.



M400XR VIDEO TRACKING

Video tracking keeps the M400XR locked on any target using the visible or thermal cameras. Once engaged the system will pan and tilt the camera automatically to keep that target in view until it drops over the horizon.



Video tracking

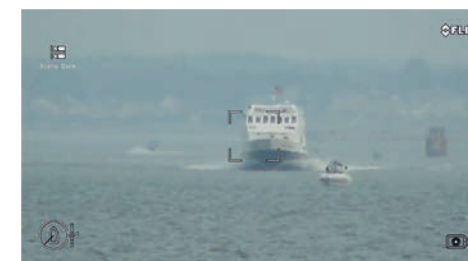

HD video camera zoom

FLIR M400/M400XR



ADVANCED INTEGRATION

The M400 and M400XR offer multiple integration options. View and control them from leading marine MFDs from Furuno, Garmin, Raymarine and Simrad. The supplied JCU-3 joystick also offers primary control and access to all the M400 features. IP video allows the camera to network with onboard video surveillance systems and HD-SDI output provides broadcast quality video to compatible displays. Analog output is also available for most marine displays and monitors. NMEA 0183 integration allows the M400/M400XR to slew to radar cursor location, ARPA targets, or the active waypoint location.

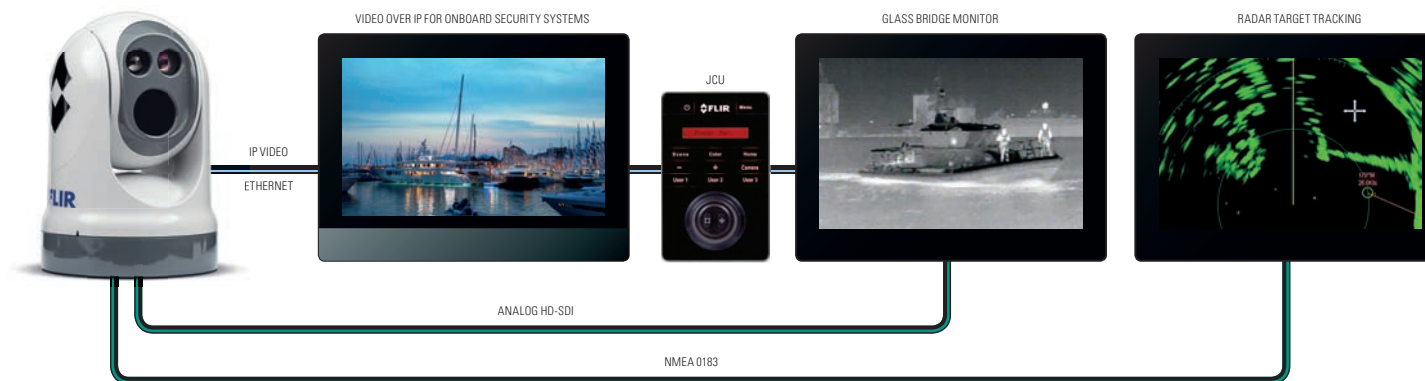



MARINE FIREFIGHTING MODE [M400XR MODEL ONLY]

The M400XR adds a marine firefighting mode engineered for fireboats and rescue craft. Survey the scene and immediately see hotspots with a firefighting-specific isothermic color palette. M400XR instantly shows you temperatures on-screen to help you visualize your plan of attack, locate hot spots, and save lives and property. M400XR sees through smoke, steam and darkness and identifies targets in scenes with extreme temperature dynamics.

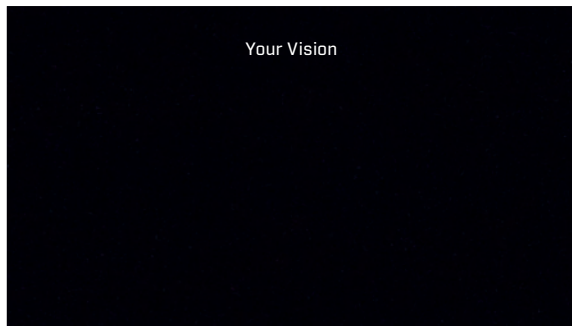

Your Vision

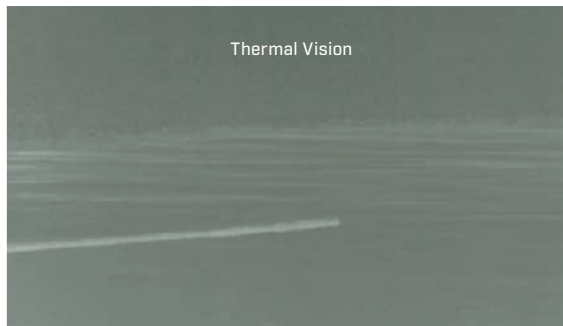

Thermal Vision



HD Visible Camera and Spotlight

INTEGRATED LED SPOT LIGHT

Use the M400's integrated spotlight to point out targets of interest, confirm navigational aids, light up the rescue zone, or just signal *I see you*. The narrow-beam LED spotlight is precisely aligned with the thermal and video camera payloads making it easy to illuminate any target without embarrassing other vessels or spoiling the night vision of on-deck crew.

FLIR M500™

NEW FOR 2017



FLIR

M500 FEATURES

- Cooled MWIR Thermal imager with 640 x 512 resolution and 14x Optical Zoom

- High intensity LED spot-beam can highlight targets of interest, while preserving the night vision of on-deck personnel

- HD Color lowlight camera with 30x optical zoom

- Gyro stabilized to ensure steady viewing in heavy sea conditions

- Rugged, waterproof gimbal enclosure with automatic window heaters for ice management.

- 360° pan and +/-90° tilt capability

- Video tracking: follow objects in the camera's view

- IP** IP Video, HD-SDI, and Analog video outputs and integration with navigation displays

M500 ULTRA HIGH PERFORMANCE MULTI-SENSOR CAMERA SYSTEM

CRYOGENICALLY COOLED FOR EXTREME LONG-RANGE DETECTION

M500's liquid helium cooling system chills its internal sensor to a frigid -387° F (-233°C) making it super-sensitive even at long range. M500 can detect a man-sized target at ranges approaching 5-nautical miles, and small vessels at over 8 nautical miles. M500 lets you detect vessels and classify onboard activities at extreme standoff ranges.

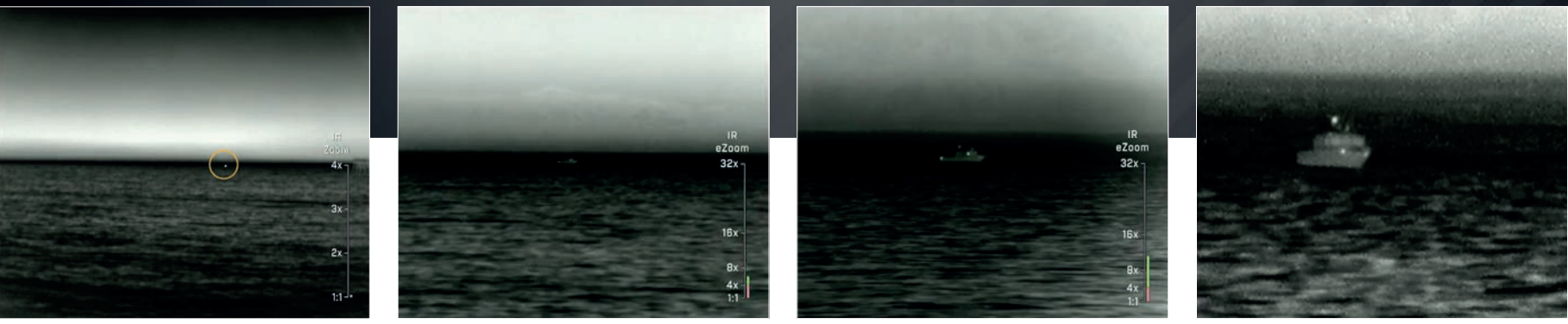

See well beyond visual range to identify distant contacts, or magnify small objects for easy identification.

THERMAL VISION WITH CONTINUOUS OPTICAL ZOOM

M500's thermal camera core features a 14x optical zoom lens plus an additional 4X digital zoom. See well beyond visual range to identify distant contacts, or magnify small objects for easy identification. With continuous optical zoom targets remain in clear, crisp focus right up to maximum magnification. Use the digital zoom to further expand the thermal image, making maximum usage of even the smallest pixels.

FLIR M500™

NEW FOR 2017

ADVANCED RADAR INTEGRATION

Link the M500 with your NMEA0183 compatible radar and enjoy an even higher level of integration. M500's pan and tilt gimbal can receive coordinates from the radar system and slew to them automatically. Quickly identify tracked ARPA targets. Place the radar cursor on an unknown target and let the M500 show you what's there. M500 can even auto-slew to show you visually the bearing to your next GPS waypoint.

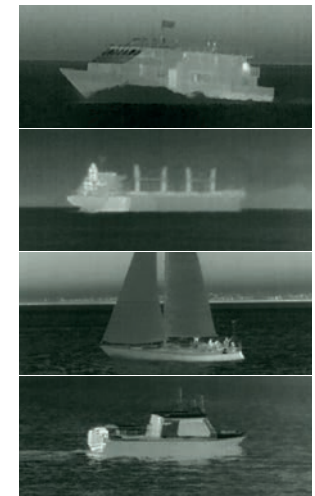
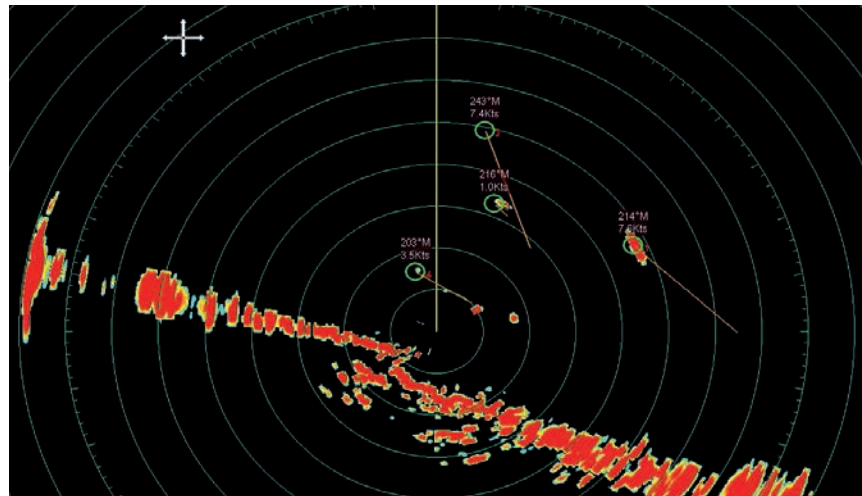

M500's advanced radar integration enables the camera auto-slew between multiple tracked ARPA targets.



SUPERIOR ALL-WEATHER THERMAL IMAGING

M500's cooled thermal sensor has twice the sensitivity of uncooled systems. This gives enhanced contrast, clarity and detail in every image. Plus, M500 sees in the Mid-Wave Infrared (MWIR) spectrum. Fog, smoke, haze and offshore marine layer are nearly invisible in this spectral range.



VIDEO TRACKING

Video tracking keeps the M500 locked on any target using the visible or thermal cameras. Once engaged the system will pan and tilt the camera automatically to keep that target in view until it drops over the horizon.

Select any in-view object of interest with the M500's joystick controller to enable video tracking.

FLIR M500™

NEW FOR 2017

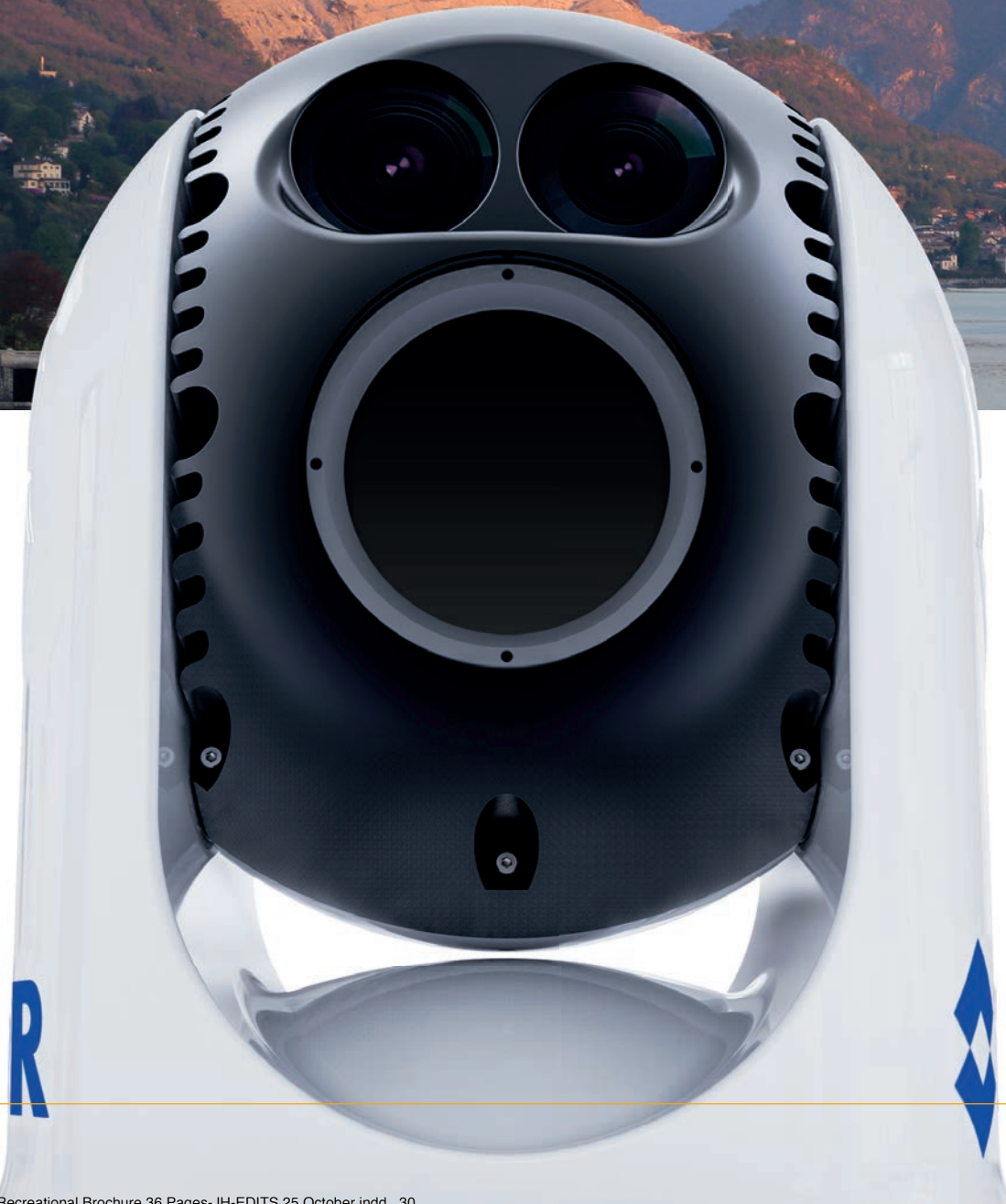

INTEGRATED LED SPOT LIGHT

Use the M500's integrated spotlight to point out targets of interest, confirm navigational aids, light up the rescue zone, or just signal *I see you*. The narrow-beam LED spotlight is precisely aligned with the thermal and video camera payloads making it easy to illuminate any target without embarrassing other vessels or spoiling the night vision of on-deck crew.



DETECTION RANGES*





HD ZOOM VIDEO CAMERA

Better than binoculars, M500 also packs a built-in color high-definition camera with optical zoom and lowlight imaging. Use the video camera to make positive identification of other vessels, navigation aids, and more. Use its 30X optical zoom to see all the details, and assess situations from a safe distance. Video and thermal zoom controls can be linked for easy comparison or simultaneous viewing using 2 monitors.



Integrated LED spotlight.



High sensitivity mid wave detector offers the best image quality and long range object recognition.



M500 allows you to observe human activity at extremely long ranges.

~4.9 nm / 9.0 km

~8.3 nm / 15.4 km

*Actual range may vary depending on camera set-up, environmental conditions, and user experience.

THERMAL CAMERA FEATURES COMPARISON CHART

Thermal Night Vision: Day or night operation without any ambient light.	
Digital Thermal Zoom: Thermal image is magnified by pixel stretching, making small or distant targets appear larger for easier viewing.	
Analog Video Output: Connect the camera to monitors, televisions and marine displays with standard composite analog video.	
Multifunction Display Integration: Controllable from major brands of marine multifunction displays like Raymarine, Garmin, Furuno and Simrad.	
Tilt Control: Adjust the camera's viewing angle +/- 90° to compensate for vessel running angle.	
Video over IP Output: Streams network video over standard Ethernet networks to computers and compatible marine multifunction displays.	
MFD Slew-to-Queue: The thermal camera can respond to queues from a networked marine multifunction display. Queues include dangerous ARPA or AIS contact alarms, the GPS position of a man overboard alarm, or locking onto a point designated from the electronic chart.	
Pan & Tilt Control: Slew the camera +/- 360° horizontally and +/-90° vertically for horizon-to-horizon viewing of targets.	
Color Lowlight Video Camera: Augments the thermal imager with color and lowlight video for positive target verification and enhanced surveillance, 36X optical zoom.	
HD Color Lowlight Video Camera: High Definition visible camera with optical zoom for positive target verification and enhanced surveillance.	
Optical Thermal Zoom: Advanced lens system magnifies small objects or distant targets for easy identification. Targets remain in clear, crisp focus right up to maximum optical magnification.	
Video Tracker: Lock the camera on a suspect, victim, or incident scene. The camera's pan and tilt system will keep the target in-frame, automatically.	
Radar Integration: Send coordinates from your radar system to the camera's pan and tilt drive to keep selected radar targets in view. Follow the radar cursor, or see GPS waypoints.	
Cooled Thermal Technology: Cryogenically cooled Mid-Wave Thermal Imager brings double the sensitivity for extreme long-range capability, and more detailed imaging.	
Vessel Detection: What is the typical detection range for a small vessel?	

PRODUCT SPECIFICATIONS

OCEAN SCOUT 240	OCEAN SCOUT 320	OCEAN SCOUT 640
		

GENERAL			
Detector Resolution	240 x 180	336 x 256	640 x 512
Refresh Rate	9 Hz		
Field of View	24° x 18°	17° x 13°	18° x 14°
Zoom	NA	2x E-Zoom	2x and 4x E-Zoom
Colour Palettes	White Hot / Black Hot / InstAlert™		
Battery	Internal Lithium Ion rechargeable (5-hour typical life)		
Waterproofing	IP-67 Submersible to 1 Meter		
Weight	0.75lb (0.34 kg)		
RANGE PERFORMANCE			
Man	1,150 ft (350 m)	1,800 ft (550 m)	3,705ft (1.14 km)
Vehicle/vessel	0.48 nm (0.90 km)	0.84 nm (1.5 km)	1.73 nm (3.2 km)

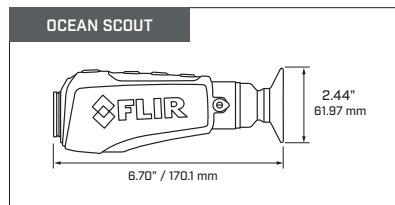



	MD-324	MD-625
MAIN THERMAL CAMERA		
Detector Type	320 x 240 VOx Microbolometer	640 x 480 VOx Microbolometer
Video Refresh Rate	<9 Hz or 30 Hz (NTSC and PAL)	
Field of View	24° x 18° (NTSC)	25° x 20° (NTSC)
Focal Length	19 mm	25 mm
Focus	Fixed 12ft (3.6m) to infinity	
Optical Zoom	N/A	
E-Zoom	2x	2x, 4x
Image Processing	FLIR Proprietary Digital Detail Enhancement	
SYSTEM SPECIFICATIONS		
Video Tracking	No	
Firefighter Mode	No	
Pan/Tilt Adjustment Range	Pan: ±30° per key, Tilt: +34°, -27° (Locked in at Installation)	
Analog Video Output	NTSC or PAL, 30 Hz or <9 Hz	
Analog Video Connector Types	F-type BNC with BNC-to-RCA adapter included for video out	
Network Video Output	No	
HD-SDI Lossless Video Output	No	
Power Requirements	12-24 V DC via included PoE injector	
Power Consumption	4.8 W nominal; 12.5 W max	
ENVIRONMENTAL		
Operating Temperature Range	-13°F to +131°F (-25°C to +55°C)	
Storage Temperature Range	-40°F to +185°F (-40°C to +85°C)	
Automatic Window Defrost	Standard at Power-Up	
Sand/Dust Ingress	Mil-Std-810E	
Water Ingress	IPX 6 (heavy seas, powerful jets of water)	
Shock	15 g vertical, 9 g horizontal	
Vibration	IEC 60945; MIL-STD-810E	
Lightning Protection	Standard	
Salt Mist	IEC60945	
Wind	100 knot (115.2 mph)	
EMI	IEC 60945	
PHYSICAL		
Weight	~ 3 lbs (1.36 kg)	
Size	6" (152.4 mm) dia. x 7" (177.8 mm) ht.	
RANGE PERFORMANCE		
Person in the Water	1,500 ft (457 m)	2,700 ft (823 m)
Small Vessel	4,200 ft (1280 m)	1.2 nm (2.2 km)



GENERAL	
Detector Type	320 x 240 VOx Microbolometer
Video Refresh Rate	9 Hz
Field of View	24° x 18°
Focal Length	19 mm
E-Zoom	4x Continuous
Image Processing	FLIR Proprietary Digital Detail Enhancement
SYSTEM SPECIFICATIONS	
Pan/Tilt Range	M100 – Tilt: +110°, -90° M200 – Pan: 360° (continuous), Tilt: +110°, -90°
Video Output	H264 IP Video stream
Power Requirements	12 or 24 VDC
Power Consumption	15 W (typical) 18 W (max)
ENVIRONMENTAL	
Operating Temperature Range	-13°F to +131°F (-25°C to +55°C)
Storage Temperature Range	-30°F to +158°F (-30°C to +70°C)
Relative Humidity	95% max
Automatic Window Defrost	Standard at Power-Up
Water Ingress	IPX 6 (heavy seas, powerful jets of water)
Shock	15 g vertical, 9 g horizontal
Vibration	IEC 60945; MIL-STD-810E
Salt Mist	IEC 60945
Wind	100 mph (161 kph)
EMI	IEC 60945
PHYSICAL	
Weight	6.0 lb (2.7 kg) w/o top-down riser 6.6 lb (3.0 kg) w/ top-down riser
Size	6.34" (dia. @ base) x 9.03" (ht.) 161.1 (dia.) x 229.3 (ht.) mm
RANGE PERFORMANCE	
Person in the Water	~1,500 ft (457 m)
Small Vessel	~0.67 nm (1.3 km)

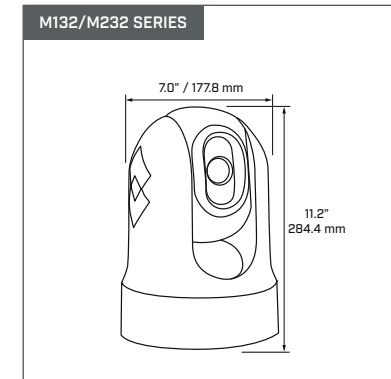
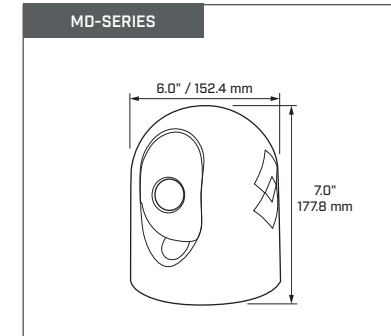

www.flir.com

Specifications subject to change without prior notice. Images for reference purposes only



	M-324S	M-324CS	M-625S	M-625CS	M-617CS
MAIN THERMAL CAMERA					
Detector Type	336 x 256 VOx Microbolometer			640 x 512 VOx Microbolometer	
Video Refresh Rate	< 9 Hz or 30 Hz (NTSC)	< 9 Hz or 30 Hz (NTSC)	< 9 Hz or 30 Hz (NTSC)	< 9 Hz or 30 Hz (NTSC)	< 9 Hz or 30 Hz (NTSC)
Field of View	24° x 18°	24° x 18°	25° x 20°	25° x 20°	17° x 14°
Focal Length	13 mm	13 mm	25 mm	25 mm	35 mm
Focus	Fixed 14 ft (4.4 m) to infinity	Fixed 14 ft (4.4 m) to infinity	Fixed 69 ft (21 m) to infinity	Fixed 69 ft (21 m) to infinity	Fixed 69 ft (21 m) to infinity
Continuous E-Zoom	4x	4x	4x	4x	4x
Image Processing	FLIR Proprietary Digital Detail Enhancement			FLIR Proprietary Digital Detail Enhancement	
MAIN VISIBLE CAMERA					
Detector Type	N/A	1/2" Interline Transfer Lowlight CCD	N/A	1/2" Interline Transfer Lowlight CCD	1/2" Interline Transfer Lowlight CCD
Lines of Resolution	N/A	530	N/A	530	530
Minimum Illumination	N/A	1.4 Lux	N/A	1.4 Lux	1.4 Lux
Optical Zoom	N/A	36x	N/A	36x	36x
E-Zoom	N/A	12x	N/A	12x	12x
SYSTEM SPECIFICATIONS					
Video Tracking	No				
Firefighter Mode	No				
Pan/Tilt Adjustment Range	360° Continuous Pan, +/-90° Tilt				
Analog Video Output	NTSC, 30Hz or <9Hz				
Analog Video Connector Types	F-type BNC with BNC-to-RCA adapter included for video out			F-type BNC with BNC-to-RCA adapter included for video out	
Network Video Output	No				
HD-SDI Lossless Video Output	No				
Power Requirements	12-24 V DC				
Power Consumption	25 W nominal; 50 W max				
ENVIRONMENTAL					
Operating Temperature Range	-13°F to +131°F (-25°C to +55°C)				
Storage Temperature Range	-40°F to +185°F (-40°C to +85°C)				
Automatic Window Defrost	Standard at Power-Up				
Sand/Dust Ingress	Mil-Std-810E				
Water Ingress	IPX 6 (heavy seas, powerful jets of water)			IPX 6 (heavy seas, powerful jets of water)	
Shock	15 g vertical, 9 g horizontal				
Vibration	IEC 60945; MIL-STD-810E				
Lightning Protection	Standard				
Salt Mist	IEC60945				
Wind	100 knot (115.2 mph)				
EMI	IEC 60945				
PHYSICAL					
Weight	~ 9 lbs (4 kg)				
Size	7" (177.8 mm) dia. x 11.2" (284.4 mm) ht.				
RANGE PERFORMANCE					
Person in the Water	1,500 ft (457 m)	1,500 ft (457 m)	2,700 ft (823 m)	2,700 ft (823 m)	4,900 ft (1,494 m)
Small Vessel	4,200 ft (1,280 m)	4,200 ft (1,280 m)	1.2 nm (2.2 km)	1.2 nm (2.2 km)	2.1 nm (3.9 km)

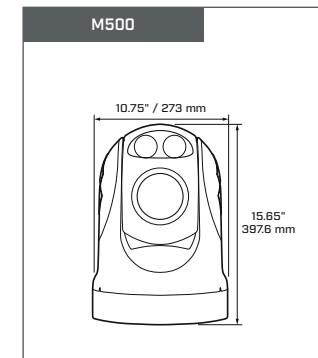
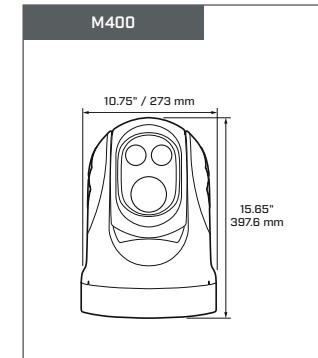
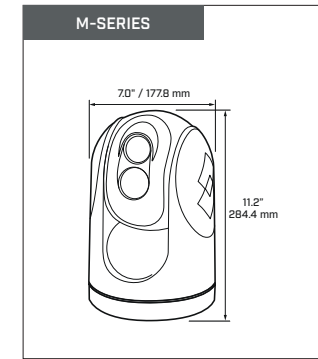

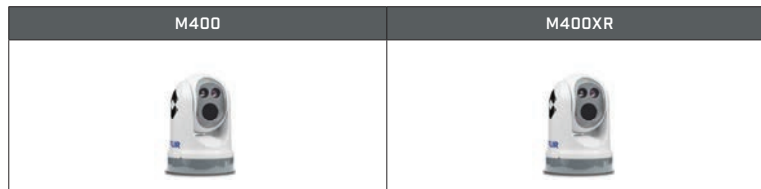

MAIN THERMAL CAMERA	
Detector Type	640 × 480 VOx Microbolometer
Video Refresh Rate	<9 Hz or 30 Hz (NTSC and PAL)
Field of View	18° to 6° HFOV / 1.5° HFOV with E-Zoom
Focal Length	35 mm (Wide) to 105 mm (Narrow)
Optical Zoom	1× to 4×
E-Zoom	1× to 4×
Image Processing	FLIR Proprietary Digital Detail Enhancement
MAIN VISIBLE CAMERA	
Detector Type	Long-range color daylight and low-light viewing
Lines of Resolution	High Definition up to 1080/30p
Minimum Illumination	>0.5 lux at 50 IRE / .05 lux in ICR Mode (B/W)
Zoom	30× Optical Zoom
Focal Length	129 mm to 4.3 mm
Field of View	64° to 2.3° Optical HFOV / 0.2 NFOV E-Zoom
SPOTLIGHT SPECIFICATIONS	
Type, Lumens, Beam*	LED, 580 Lumens, 5° Divergence Angle
SYSTEM SPECIFICATIONS	
Video Tracking	No
Radar Target Tracking	Yes
Firefighter Mode	No
Pan/Tilt Adjustment Range	360° Continuous Pan, +/-90° Tilt
Analog Video Output	NTSC or PAL, 30 Hz or <9 Hz
Analog Video Connector Types	F-type BNC with BNC-to-RCA adapter included for video out
Network Video Output	Dual, Independent H.264 Network Video Streams
HD-SDI Lossless Video Output	Yes
Power Requirements	24V DC
Power Consumption	<50 W nominal; 130 W peak, 270 W 2/heaters
ENVIRONMENTAL	
Operating Temperature Range	-13°F to +131°F (-25°C to +55°C)
Storage Temperature Range	-56° F to + 176°F (-50°C to +80°C)
Automatic Window Defrost	Standard at Power-Up
Sand/Dust Ingress	Mil-Std-810E
Water Ingress	IPX 6 (heavy seas, powerful jets of water)
Shock	15 g vertical, 9 g horizontal
Vibration	IEC 60945; MIL-STD-810E
Lightning Protection	Standard
Salt Mist	IEC60945
Wind	100 knot (115.2 mph)
EMI	IEC 60945
PHYSICAL	
Weight	28 lbs (12.7 kg)
Size	10.75" (273.1 mm) x 15.65" (397.6 mm) – 18.05" (458.7mm) high with top down riser
RANGE PERFORMANCE	
Person in the Water	1.3 nm (2.45 km)
Small Vessel	3.2 nm (6.0 km)



THERMAL CAMERA	
Detector Type	Cooled MWIR InSb 640x512 Focal Plane Array
Video Refresh Rate	25 Hz (PAL) / 30 Hz (NTSC)
Field of View Limits	Optical 28° x 21° WFOV to 2° x 1.5° NFOV
Optical Zoom	1x to 14x (continuous)
E-Zoom	4x
NETD	<30 mK
Spectral Response	3-5 µm
COLOR CAMERA	
Visible Sensor	1/2.8" CMOS
Resolution	1920 x 1080
Field of View Limits	Optical 63.7° x 35.8° WFOV to 2.3° x 1.29° NFOV
E-Zoom	12x
SYSTEM SPECIFICATIONS	
Pan/Tilt Range	
Video Interface	Analog video, HD-SDI
Video over Ethernet	2 channels of streaming MPEG-4, H.264, or M-JPEG
NMEA0183	TCP/IP, RS-422, NMEA 0183, Pelco D
Communications	TCP/IP, RS-422, Pelco D
Video Formats	NTSC or PAL NTSC or PAL, 720p30, 1080p30
Power Requirements	12 VDC to 24 VDC (-10%+30% per IEC 60945)
Power Consumption	250 W (max w/heaters)
Output Modes	Black hot, white hot, false color palettes
Contrast Enhancement	AGC or manual, histogram equalization, local contrast enhancement algorithms available
Sharpness Enhancement	Automatic, adjustable Digital Detail Enhancement
Overlays	Integrated graphics overlays to indicate azimuth, AGC, active camera and menu control
ENVIRONMENTAL	
Operating temp	-25°C to +55°C
Storage temp	-50°C to +80°C
PHYSICAL	
Weight	45 lb (20.4 kg)
Size	10.75" (273 mm) dia. x 15.65" (397.5 mm) ht
RANGE PERFORMANCE	
Person in the Water	~4.9 nm (9.0 km)
Small Vessel	~8.3 nm (15.4 km)

www.flir.com

Specifications subject to change without prior notice. Images for reference purposes only

NOTES

US EXPORT REGULATIONS

Equipment described herein is subject to US export regulations and may require a license prior to export. Diversion contrary to US law is prohibited. Imagery for illustration purposes only. Specifications are subject to change without notice. ©2017 FLIR Systems, Inc. All rights reserved

WARRANTY

FLIR's service commitment of outstanding warranty and technical support now offers you even more; by registering your system with FLIR at www.flir.com/productreg, the 2-Year Standard Limited Warranty is upgraded and replaced by the 3-Year Extended Limited Warranty for FREE.

For complete details on FLIR's industry-leading warranty please visit
www.flir.com/maritime.

FLIR SYSTEMS INC.
27700 SW PARKWAY AVE
WILSONVILLE, OR 97070
USA
503-498-3547

FLIR MARITIME US, INC.
9 TOWNSEND WEST
NASHUA, NH 03063
USA
603-324-7900

FLIR SYSTEMS BVBA
LUXEMBURGSTRAAT 2, 2321
MEER
BELGIUM
+32 (0)3 287 87 10



The World's **Sixth Sense**®

OCTOBER 2017